

# SINC - LINK

Vol. 5 No. 4

JULY - AUGUST '88

SINC-LINK IS A PUBLICATION OF THE TORONTO TIMEX-SINCLAIR USERS CLUB AND IS ISSUED 6 TIMES A YEAR. COPIES OF THE NEWSLETTER ARE \$1.50 EACH FOR NON-MEMBERS. CLUB MEMBERS RECEIVE A FREE COPY AS PART OF THE \$20.00 ANNUAL MEMBERSHIP FEE.

NEWSLETTERS ARE EXCHANGED, FREE OF CHARGE, WITH OTHER TIMEX-SINCLAIR USER GROUPS.

ALL MATERIAL IS PUBLIC DOMAIN AND CAN BE REPRINTED. PLEASE CREDIT THIS PUBLICATION AND THE AUTHOR IF YOU COPY MATERIAL.

SEND CORRESPONDANCE TO:

Attention: SINC-LINK EDITORS,  
TORONTO TIMEX-SINCLAIR USERS  
CLUB, P.O. BOX 7274 STN. A,  
TORONTO, ONTARIO, CANADA, M5W1X9

## MID-SUMMER ISSUE

Page 2	- Editorial
Page 3,4,5,6	- Bob's Notebook <small>RENAME RECOVER COPY</small>
Page 7	- Game Hacks
Page 8	- PC8300 ROM Update
Page 9	- Larkin RAMdisk Review
Page 10	- Colour Printouts
Page 11,12	- Computerfests
Page 13	- QL On/Off Switch
Page 14	- The Last Page

### EXECUTIVE OFFICERS:

PRESIDENT:	ED MAYBEE (743-8141)
VICE PRESIDENT:	JEFF TAYLOR (244-8583)
TREASURER:	BILL LAWSON (444-8772)
SECRETARY:	GEORGE CHAMBERS (751-7559)
ACTIVITIES DIRECTOR:	RENE BRUNEAU (531-9749)
TAPE LIBRARIAN ZX81:	" " "
TAPE LIBRARIAN 2068:	RENATO ZANNESE (635-6536)
TAPE LIBRARIAN QL :	REG COTTLE (785-3987)
PAPER LIBRARIAN :	TOM AROELLA (653-6978)
NEWSLETTER :	R. BRUNEAU, J. TAYLOR, R. ZANNESE
LIAISON OFFICER (Out-of-town members):	GEORGE CHAMBERS, 14 RICHOME COURT, SCARBOROUGH, ONTARIO, M1K 2Y1 (416-751-7559)

**TORONTO TIMEX - SINCLAIR USERS CLUB**

P. O. Box 7274 Stn. A Toronto, Ont., M5W 1X9  
Canada

## EDITORIAL

Welcome to the middle-of-the-driest-summer-in-memory issue.

If you haven't heard by now, Toronto as well as the rest of North America is suffering from near-drought conditions. But look at it positively, you won't have to spend any time or money weeding or fertilizing the grass ..... cause there isn't any!

Speaking of dry times, just prior to the June meeting, the Toronto Board of Education notified the club secretary that our meeting room would not be available through July and August. So all you regular attendees should have lots to show and talk about when we resume our meetings Wednesday, September 7th, at Forest Hills Collegiate, 730 Eglinton Ave. W., Toronto.

Still on dry times, where are all the newsletter contributors? With the exception of a few Larkin owners (our most dynamic group of writers) and the editors, contributions have almost dried up. Come on folks, don't you have anything you'd like to share with us? User clubs only prosper if members share their info. Write!

Did I say prosper? At the last club executive meeting a few of the exec expressed near-embarrassment at the extremely healthy club bank balance. In an effort to relieve their anxiety it was decided that at the June club meeting we would vote on whether to purchase a Larkin system for club demonstrations. That vote took place and those concerned exec members don't have to feel so embarrassed now. The system will be on display at the September meeting.

Jeff Taylor

### Sinclair Northamerica Users Group

During one of the organizational meetings of the recent Sunstate Timex/Sinclair WinterFest '88, the idea of a National organization for the advancement of Sinclair Computing came up. It was decided that since we had developed a "core group" that was dedicated to promoting Sinclair computing, we would attempt to lay the groundwork for such an organization. It was also mentioned that the greater the amount of time from the departure of Timex from the computer industry, the less of an active market would result. Since we would have users from across the nation at the Fest, it would be an ideal time to make our plans known. So, the Sinclair Northamerica User Group, or SNUG (a name submitted to us by John Cushran, and later modified by Bill Jones) was starting to come closer to reality.

## WHAT IS IT

The intent of SNUG is to provide a forum for exchange of ideas. It would be a source of information, such as a listing of active members, active Users groups, Sinclair specific Bulletin Boards, an active library of Public Domain software, and a listing of available shareware and freeware. Later on we hope to propose an industry standard of hardware and software compatibility. So as to not have to re-invent the wheel, and to do this in the shortest amount of time, we are going to try and use an already established group, such as the CORSA (Corvair Owners Assn.) as a model to base our group on. SNUG would act as an umbrella organization, with Regions being developed to tie in with established groups in those areas.

## WHAT IT ISN'T

It is the intent of the organizers NOT to infringe or supersede any already established User group or Vendor. It is intended to show some strength to the industry that Sinclair is not dead, and the mere fact that we can get this organization together will prove that we can stick together and grow and prosper. We look at this as an enhancement to activities that have been planned on. Hopefully, a Northamerica Calendar of events could be established to help co-ordinate any future plans and events. It is not designed to take anything away from anyone.

## WHAT TO DO

We need the support of EVERY SINGLE SINCLAIR USER! Whether you reside in Canada, the USA, or Mexico, or for that matter anywhere, we need to know how you feel and what you want in this Organization. This is your opportunity to be heard... your comments, criticisms, complaints, or praises. What we have here is nothing more than an idea. Nothing at this time is set in concrete. We are more than open to suggestions. To make it work, these ideas of yours have to be forwarded immediately. We are putting a time limit until June 30, 1988. If there is no support, we will not proceed further. If there is input, we will update on a monthly basis to whoever will put the information in print. So let's hear from you soon!!

## TEMPORARY CONTACT FOR INFORMATION

Mel Nathanson,  
7515 Arbordale Drive  
Port Rickey, FL 34668  
8813) 863 5552

Mary Lynn Johnson  
190 Hickory Woods Ct.,  
Unit 3C  
Deltona, FL 32765  
(305) 860 2465

# BOB'S NOTEBOOK

by Bob Mitchell  
DISK MANAGEMENT UTILITIES

Utilities are programs that assist in either disk management or program development. Disk management includes: Doctor, Copy, Rename, Move, etc. Program Development includes: Assemblers, Disassemblers, Compilers, Compactors, Renumbering, Toolkits in general, etc. Of course, utilities like any programs can usually be improved or edited to suit your particular needs, whims and fancies.

This article presents some changes to existing Disk Management utilities as well as one new one.

NOTE: Reference to LKDOS below means the original LARKEN version which uses the old LDOS interface board and which allows for 1960 bytes per track.

1. RENAME. Used to change a file name on an LKDOS disk. When I converted to LKDOS from LDOS, I changed 'rename' to use a disk version of the LDOS EPROM, dubbed 'LDOS64.C5'. A few minor changes to the routine made 'rename' do its job with the LKDOS cartridge. The next step was to do away with the use of LDOS64. To do this I wrote a short machine code routine to use the LKDOS EPROM. This has been dubbed RHMDS.C1. Then I incorporated this into 'rename' and compiled it using Timachine. A short boot routine in BASIC was needed to handle the CAT function since this cannot be used in the compiled version; this became my rename boot and the two short programs are at Listings 1 & 2. In the listings below, the DATA lines hold the RHMDS code; listing 1 is ready for Timachine.

2. DOCTOR. This has also been changed to run with RHMDS. Note that using this moves the DOS buffer up 2000 bytes to start at 63500 vice 61500. Thus the disk name is at 65478 to 65487 instead of 63478 to 63487 on track 0.

The routine Disk Dump gives data for each track: name, start address and length up to a max 1960 bytes. This routine cannot distinguish 'good' from ERASEd tracks. This is useful; if all the ERASEd tracks of a file are present then it is possible to recover it for further use. This is an involved process and so listing 4 presents a short RECOVER routine to do the job. It will work fine as long as there are no redundant tracks bearing the wanted file's name and of course as long as the wanted file is still intact and has not been partly overwritten by other material. Redundant tracks can result when a file is shortened and reSAVED under the original name. There may be other causes.

(Listings 3 is the boot program; Listing 4 is ready for Timachine.).

Use the routine that gives name, start address and total length of each file to get a print-out of this detail and slip the copy inside the diskette cover. With this information you can, for example, SAVE a code file to another disk without the aid of COPY or MOVE utilities.

The Examine/Modify Track routine facilitates the PEEKing and POKEing of values in addresses on any track but mainly on track 0 (directory).

One change I made caters for the use of a keyword (token) in the disk name. LKDOS allows a maximum of nine characters for the disk name. Using tokens, you can come up with some interesting longer names; eg, SUPER CODE1 (7 bytes); MAIL MERGE 88 (7 bytes). Using the tokens (CODE and MERGE in these examples) adds only one byte for each. Other possibilities: COPY AND MOVE (3 BYTES); MMI SAVE UTIL1 (9 bytes); etc, etc...

A few small changes will be needed to display a token when examining track 0 in the disk name area. Find the Track Manipulation routine in the listing and more specifically the line that goes something like : <PRINT AT 1,29;" ";AT 1,1;"addr map byte chrs\$">; add a line <LET cd=123>; then after the line <FOR x=n TO n+16> add a line <IF x=65478 THEN LET cd=255>. In the next line (the one that starts <PRINT x;TAB 9;....etc> change the value <123> to <cd>.

3. COPYDOG. Eric Michaud's copydog routine is an excellent utility which will copy a disk in five sweeps (16 tracks at a time). However, it has one minor shortcoming in that an ambiguous prompt comes up on the screen from the machine code. For example. <Insert Source... OK?>. Well the OK? doesn't make it clear that it will only accept a 'y' or an 'n'. Pressing any other key can leave you thinking the program has crashed. So I disassembled the code and found the addresses that contain this prompt and changed them to end : y/n? Here's how: POKE 32795,13: POKE 32796, CODE "y": POKE 32797, CODE "/": POKE 32798, CODE "n": POKE 32799, CODE "?"

4. COPY. The LARKEN MOVE program does a good job of COPYING files but is rather involved for LKDOS. Unless there is a need to alter a file name, I prefer the COPY utility written some time ago by George Chambers. This has been changed to incorporate the RHMDS routine as well as the LARKEN move.C2 code. This is shown at listings 5 & 6; 6 is ready for Timachine).

## LISTING 1.

```

1 REM ! LPRINT
2 REM ! LIST
3 REM !USR 58000
4 REM !INT +t,ct,i,k,j,l
5 REM !LEN i$<=5
6 REM ! OPEN #
10 DIM x$(9): DIM y$(9): DIM z
$(9): DIM a(79)
11 CLS : PRINT AT 10,0; INVERS
E 1;" RENAME "; INVERSE 0;" by B
ob Mitchell 1988"
12 LET t=1
17 LET ct=23728: POKE ct,0
20 RESTORE 9800: FOR o=63000 T
O 63076: READ p: POKE o,p: NEXT
O
27 RANDOMIZE USR 63000
29 BEEP .05,10
30 INPUT "change name from ";
LINE y$
40 FOR i=63600 TO 65440
45 IF PEEK i=255 THEN LET k=i+
1: FOR j=1 TO 9: LET x$(j)=CHR$
PEEK (i+j): NEXT j: IF x$=y$ THE
N BEEP .05,10: INPUT "change nam
e to "; LINE z$: GO TO 100
50 NEXT i
60 BEEP 1,-10: PRINT "y$;" no
t found": PAUSE 100: GO TO 10
100 FOR i=1 TO 9: POKE i,CODE Z
$(i): LET k=k+1: NEXT i
110 RANDOMIZE USR 63000
150 IF PEEK k(>)253 THEN LET k=k
+1: GO TO 150
155 GO TO 170
160 IF PEEK (k+1)=249 OR t>79 T
HEN GO TO 200
170 LET k=k+1: IF PEEK k>128 AN
D PEEK k<200 THEN LET a(t)=PEEK
k: LET a(t)=a(t)-128
180 LET t=t+1: GO TO 160
200 LET t=1
205 POKE ct,a(t)
210 RANDOMIZE USR 63000
220 FOR l=1 TO 9: POKE 63505+l,
CODE z$(l): NEXT l
225 RANDOMIZE USR 63000
230 LET t=t+1: IF a(t)<>0 THEN
GO TO 205
500
510 CLS : BEEP .2,10: PRINT AT
10,0; PAPER 2; INK 7;"Program ha
s been renamed ""from ";y$;"
to ";z$
520 INPUT "m=more q=quit "; LI
NE i$
530 IF i$="m" THEN GO TO 10
540 IF i$<>"m" THEN STOP
550 STOP
9800 DATA 195,40,246,195,69,246,
243,205
9801 DATA 98,0,201,58,100,0,251,
201
9802 DATA 205,30,246,58,176,92,5
0,29
9803 DATA 32,205,126,0,205,123,0
,33
9804 DATA 112,32,17,16,248,1,192
,7
9805 DATA 237,176,195,35,246,205
,30,246
9806 DATA 58,176,92,50,29,32,33,
16
9807 DATA 248,17,112,32,1,192,7,
37
9808 DATA 176,205,150,0,205,126,
0,205
9809 DATA 120,0,195,35,246,0,0,0
9900 REM ! CLOSE #
9910 CLEAR : RANDOMIZE USR 100:
SAVE "rename.Bp" LINE 10

```

## LISTING 2.

```

10 REM rename boot
90 PAPER 7: BORDER 7: INK 9: C
LS
200 RANDOMIZE USR 100: LOAD "re
name.Cc"CODE
410 PRINT #1; INVERSE 1;" RENAM
E "; INVERSE 0;" by Bob Mitchell
1988""Change name routine.""I
nserf Disk. [ENTER] when ready"
411 BEEP .05,1
412 PAUSE 0
415 CLS
420 RANDOMIZE USR 100: CAT "",
421 BEEP .05,1
423 PRINT #1;AT 0,0;"[ENTER]":
PAUSE 0
425 BEEP .05,1
427 POKE 23658,0
430 RANDOMIZE USR 50000
500 PRINT AT 20,0;"[ENTER]=rest
art [STOP]=disk menu"
505 INPUT LINE i$
510 IF i$=CHR$ 225 THEN RANDOMI
ZE USR 100: LOAD "menu.B1"
520 IF i$<>CHR$ 225 THEN CLS :
GO TO 410
550 STOP
1000 RANDOMIZE USR 100: SAVE "re
name.Bb" LINE 1100
1010 STOP
1100 GO TO 1

```

90 CLS

95 LET add=55000

98 PAPER 7: INK 0: BORDER 7: C

LS

100 PRINT INVERSE 1;" RECO  
VER I/O Routines "; INVERSE0""by Bob Mitchell Willowdale O  
nt.""1. RUN ""2. CATALOGUE""

3. RESTART""4. QUIT"

105 PRINT ""WARNINGS!""Do NOT u

se this program to recover

files which have either been ove

rwritten by other material

or which have been shortene

d or otherwise changed thereby

leaving redundant tracks o

n the disk with the same nam

e."

106 PRINT ""If in doubt, use DO

CTOR to check first."

107 PRINT #1;"Press selection (

keys 1 TO 4)"

110 LET d\$=INKEY\$

115 IF d\$&lt;"1" OR d\$&gt;"4" THEN GO

TO 110

120 IF d\$="1" THEN CLS : GO TO

300

130 IF d\$="2" THEN GO TO 400

140 IF d\$="3" AND PEEK add=205

THEN CLS : GO TO 500

145 IF d\$="4" THEN RANDOMIZE US

R 100: LOAD "menu.B1"

150 GO TO 110

300 POKE 23658,0

315 RANDOMIZE USR 100: LOAD "re

covr.Cc"CODE

340 RANDOMIZE USR add

350 GO TO 10

400 CLS : RANDOMIZE USR 100: CA

T "",: PRINT #1;"[ENTER]": PAUSE

0

410 CLS : GO TO 100

420 GO TO 1

510 RANDOMIZE USR add

520 CLS : GO TO 1

999 STOP

1000 RANDOMIZE USR 100: SAVE "re

covr.Bb"

1005 PAPER 7: INK 9: BORDER 7: C

LS

1010 RUN

## LISTING 3.

## LISTING 4.

```

100 REM !USR 55000
102 REM !LEN $<=20
104 REM ! LIST
120 REM ! OPEN #
130 LET curtrack=23728: POKE cur
    track,0
135 DIM g$(9): DIM x$(9): DIM y
    $(9): DIM z$(9): DIM a(79): DIM
    b(22)
140 RESTORE 5500: FOR o=63000 T
    O 63102: READ p: POKE o,p: NEXT
    o
145 CLS : PRINT AT 3,0;"          L
    ARKEN LKDOS UTILITY""
    FILE RECOVERY""This program w
    ill recover a file that has been
    ERASED providing that none of i
    ts tracks has been overwritten by
    other material.""          by Bob
    Mitchell 1988 "
146 LET st=0
150 INPUT "name of file to be r
    ecovered? ",i$
151 IF LEN i$<9 THEN LET i$=i$+
    " ": GO TO 151
152 LET y$=i$
155 RANDOMIZE USR 63000
157 CLS : BEEP .1,10: PRINT "sc
    anning directory track for"y$
160 FOR i=63600 TO 65478
170 IF PEEK i=255 THEN FOR j=1
    TO 9: LET x$(j)=CHR$(PEEK (i+j)):
    NEXT j: IF x$(2 TO )=y$(2 TO )
    THEN GO TO 200
180 NEXT i
190 GO TO 2000
200 PRINT "y$;" found"": BEEP
    .1,10: PRINT "scanning for track
    s containing ""y$"" track #s are
    : FOR i=1 TO 79
    205 POKE curtrack,i
    210 OUT 84,8: PAUSE 3
    220 RANDOMIZE USR 63000
    230 FOR j=1 TO 9: LET z$(j)=CHR
    $(PEEK (j+63585)): NEXT j
    240 IF z$(2 TO )=y$(2 TO ) AND
    i<80 THEN GO SUB 300
    250 NEXT i
    255 GO SUB 350
    260 GO TO 400
    300 IF PEEK 63585=0 THEN RETURN

310 LET a(i)=PEEK 63585
320 RETURN
350 LET i=1: FOR t=1 TO 79
355 IF a(t)=0 THEN GO TO 370
360 LET b(i)=a(t): PRINT b(i);"
    ";
365 LET i=i+1
370 NEXT t
380 PAUSE 60
400 POKE curtrack,0: RANDOMIZE
    USR 63000
401 IF st THEN STOP
405 CLS : BEEP .1,10: PRINT "c
    orrecting track #ap"
410 FOR j=1 TO 22: FOR i=63529
    TO 63607: IF PEEK i=b(j) THEN PR
    INT PEEK i;" changed to: "; POK
    E i,(b(j)+128): PRINT PEEK i
420 NEXT i
430 NEXT j
500 IF st THEN STOP
502 BEEP .1,10: PRINT "restorin
    g name and tracks used."
    FOR i=63600 TO 65478 STEP 3

```

```

520 IF PEEK i=255 AND PEEK (i+1
    )=254 THEN FOR j=1 TO 9: LET g$(
    j)=CHR$(PEEK (i+j))
535 IF j=9 THEN GO TO 545
540 NEXT j
545 IF g$(2 TO )=y$(2 TO ) THEN
    LET m=i: IF PEEK (m+1)=254 THEN
    GO TO 600
550 NEXT i
560 GO TO 730
600 POKE m+1,CODE y$
605 FOR p=1 TO 22
610 IF b(p)<>0 THEN POKE m+p+10
    ,(b(p)+128)
615 IF b(p)=0 THEN GO TO 630
620 NEXT p
630 POKE m+p+10,249
700 POKE curtrack,0
720 RANDOMIZE USR 63000
730 CLS : LET st=1: PRINT "Task
    Completed. Check Catalogue.""
    PRESS A KEY"
735 PAUSE 0
740 STOP
2000 PRINT #1;AT 0,0;"File not f
    ound": BEEP .5,.1: PAUSE 100: ST
    OP
5500 DATA 195,43,246,195,72,246,
    195,184
5501 DATA 246,243,205,98,0,201,5
    8,100
5502 DATA 0,251,201,205,33,246,5
    8,176
5503 DATA 92,50,29,32,205,126,0,
    205
5504 DATA 123,0,33,112,32,17,16,
    248
5505 DATA 1,192,7,237,176,195,38
    ,246
5506 DATA 205,33,246,58,176,92,5
    8,29
5507 DATA 32,33,16,248,17,112,32
    ,1
5508 DATA 192,7,237,176,205,150,
    0,205
5509 DATA 126,0,205,120,0,195,38
    ,246
5510 DATA 205,33,246,205,129,0,2
    05,123
5511 DATA 0,33,112,32,17,16,248,
    1
5512 DATA 192,7,237,176,195,38,2
    46,0
8100 REM ! CLOSE #
8999 STOP
9000 CLEAR : RANDOMIZE USR 100:
    SAVE "recovr.Bp" LINE 1
9010 STOP
9100 CLEAR : SAVE "recovr.Bp"

```

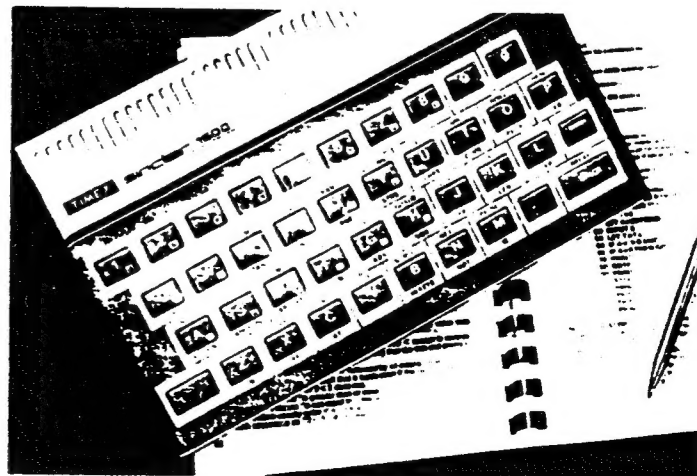

## LISTING 5.

```

6 REM !USR 29000
7 REM !INT +i,f,a,tlen,pass,f
n,z,q,y,mem,owta,dwta,onam,dna
r,indir,ld1,ld2,svnam,svdata,svend,nbcs,bsize
8 REM !LEN $(=20
10 REM ! OPEN #
13 GO SUB 7000: GO SUB 9700
14 PAPER 7: INK 9: BORDER 7: C
LS
15 POKE 23658,0
16 PRINT AT 0,0;"Insert disk t
o be copied and"" press any k
ey": PAUSE 0: CLS
20 POKE 23728,0: RANDOMIZE USR
63000
25 CLS
30 FOR n=63600 TO 65470
40 IF PEEK n=255 AND PEEK (n+1
)<>254 THEN GO SUB 100
42 POKE 23692,255
45 IF PEEK n=250 THEN PRINT ""
End of Disk Directory"" [m]=Dis
k Menu; [ENTER]=next disk": PAUSE
0: GO TO 100
50 NEXT n
100 LET a$=""
105 LET z=0
110 FOR y=1 TO 9
113 IF PEEK (n+1)=46 THEN LET z
=1
115 IF PEEK (n+1)=32 AND z=1 TH
EN LET y=9: GO TO 130
120 LET a$(y)=CHR$(PEEK (n+1)):
PRINT INK 1,CHR$(PEEK (n+1)); INK
0;
125 LET n=n+1
130 NEXT y
137 PRINT " Copy? (y/n)"
138 PAUSE 0
139 IF INKEY$="n" THEN RETURN
140 IF INKEY$="y" THEN GO TO 10
00
141 GO TO 130
100 STOP
1000 DIM f$(9): GO SUB 7000
1005 LET f$=a$
1010 FOR f=1 TO 9: POKE Onam,COO
E f$(f): LET Onam=Onam+1: NEXT f
1130 FOR a=1 TO 9: POKE Dnam,COO
E f$(a): LET Dnam=Dnam+1: NEXT a
1140 PRINT #1,AT 0,0;"Copying ";
f$
1200 LET rt=USR indir
2000: LET rt=USR Ld1
2010 LET Tlen=PEEK 34002: LET pa
ss=1: IF Tlen>(PEEK Nbcs)-1 THEN
LET pass=2
2100 GO SUB 7400
2200 LET rt=USR svnam
2300 LET rt=USR svdata
2400 IF pass=1 THEN GO TO 5000
2500 GO SUB 7300: LET rt=USR Ld2
2700 GO SUB 7400: LET rt=USR svd
ata
5000 LET rt=USR svend
5050 PRINT #0,AT 0,0;"File copie
d": BEEP .1,10: BEEP .1,10: PAUS
E 200: GO SUB 7300: RETURN
6500 BEEP .5,5: BEEP .5,1: PAUSE
60: GO TO 14
7000 LET Mem=34000: LET Owta=347
00: LET Dwta=34750: LET Onam=346
0: LET Dnam=34650
/100 LET indir=32000: LET Ld1=32
003: LET Ld2=32006: LET svnam=32
009: LET svdata=32012: LET svend
=32015: LET Renam=32010
7150 LET Nbcs=34003: LET Bsize=3
4004

```

32 = space  
46 = .

```

7170 POKE Nbcs,14: POKE Bsize,2:
POKE Bsize+1,0
7200 RETURN
7300 INPUT "Insert Original Disk
";a$: RETURN
7400 INPUT "Insert Destination D
isk";a$: RETURN
7990 RETURN
9700 RESTORE 9800: FOR i=63000 T
O 63070: READ o: POKE i,o: NEXT
i: RETURN
9800 DATA 195,40,246,195,69,246,
243,205
9801 DATA 98,0,201,50,100,0,251,
201
9802 DATA 205,30,246,50,176,92,5
0,29
9803 DATA 32,205,126,0,205,123,0
,33
9804 DATA 112,32,17,16,248,1,192
,7
9805 DATA 237,176,195,35,246,205
,30,246
9806 DATA 58,176,92,50,29,32,33,
16
9807 DATA 248,17,112,32,1,192,7,
237
9808 DATA 176,205,150,0,205,126,
0,205
9809 DATA 120,0,195,35,246,0,0,0
9899 REM ! CLOSE #
9900 RANDOMIZE USR 100: SAVE "co
py.Bp" LINE 1

```

```

90 CLS
95 LET add=29000
98 PAPER 7: INK 0: BORDER 7: C
LS
100 PRINT "COPY I/O Routines""
""1. RUN ""2. CATALOGUE""3. RE
START""4. QUIT"
105 PRINT ""Press selection"
110 LET d$=INKEY$
115 IF d$<"1" OR d$>"4" THEN GO
TO 110
120 IF d$="1" THEN CLS : GO TO
300
130 IF d$="2" THEN GO TO 400
140 IF d$="3" AND PEEK add=205
THEN CLS : GO TO 500
145 IF d$="4" THEN RANDOMIZE US
R 100: LOAD "menu.B1"
150 GO TO 110
300 POKE 23658,0
315 RANDOMIZE USR 100: LOAD "co
py.Cc"CODE
320 RANDOMIZE USR 100: LOAD "mo
ve.Cz"CODE
340 RANDOMIZE USR add
350 GO TO 10
400 CLS : RANDOMIZE USR 100: CA
T "",: PRINT #1,"[ENTER]": PAUSE
0
410 CLS : GO TO 100
420 GO TO 1
510 RANDOMIZE USR add
520 CLS : GO TO 1
999 STOP
1000 RANDOMIZE USR 100: SAVE "co
pyio.B2"
1005 PAPER 7: INK 9: BORDER 7: C
LS
1010 RUN

```

## LISTING 6.

Note: You will need a copy of LARKEN "move.Cz" to make this work

GAME HACKS  
by Douglas Jeffery

hacks .CT

I have been asked to write a regular column on game hacking, etc. I have collected a lot of material on hacks and things for the Spectrum and will be happy to write about them. What I do need is feed-back. I don't know what you want to know or how I can best fill your needs. I also can use any hints, pokes, etc. you can give me. Please write me : DOUGLAS JEFFERY Larch Rd., R.R. #1, Telkwa, B.C. V0J 2X0. Thanks for their help goes out to Paul Burbridge of Ottawa and Bill Rutter of Burnaby for the hints and stuff they sent.

PAPERBOY 10 REM by Jon North '86 30 PRINT "Play from the start": LOAD "" CODE 40 FOR f=65046 TO 1e9 : IF a&256 THEN POKE f,a : NEXT f 50 RAND USR 65e3 60 DATA 62,182,50,145,197: REM infinite lives 70 DATA 62,45,50,111,192: REM infinite papers 80 DATA 999: REM end marker-do not delete!!

LAP OF THE GODS by Mark Robb On the High Score Table : (type) CHEAT

SABOTEUR 10 CLEAR 24200 20 LOAD "" SCREENS 30 LOAD "" CODE 40 POKE 29894,0 50 RANDOMIZE USR 63972

ATIC ATAC MERGE header and LIST. To edit line 0, POKE 23756,1 & ENTER. EDIT line 1 and insert POKE 36519,0 (inf. lives) or POKE 35363,0 (inf. energy) before PRINT USR statement. RUN & start tape.

BARBARIAN POKE 65518,50 kill only 1 man to finish. POKE 65513,50 immortal POKE 36192,0 infinite energy

GUNRUNNER POKE 49171,0 infinite lives POKE 52549,0 don't re-start after death

AIRWOLF 2 POKE 48356,201 immortal POKE 53471,0 ???????

ADVENTURE HINTS

AFTERSHOCK To get out of building. (take chair to lift, climb on chair, examine ceiling, remove panel, & climb out of lift.) To drain flooded tunnel. (go to storm drain, switch on torch, go E,S,S,S, to sluicgate then S,E,E,E to find handle, return to sluicgate, connect handle, lube mechanism, open sluicgate.)

COLDITZ Ask for HELP in storeroom & you end up in town. The Rusty Dagger is in the twisty sewers. The sewers are through the coffin you need the crowbar then the screwdriver.

SEABASE DELTA To get new travel permit. (take old card to autojclerk & sign form.) To get object from table (wear flippers) To wake hen (have gum & blow bubble) NOTE: keep gum to (Gum button in lift) To open heavy metal door (you need the tape & tape player)

ZORK 1 "Climb Tree" to find egg in forest. "Move leaves" to uncover grating. "Open Window" to access house. "Move Rug" to find trap door.

Well, that's all for this time. Please let me know what you would like to see in this column? I welcome any information on any program for the 2068 & Spectrum.  
\*\*\*\*\*

More Game Pokes  
Renato Zannese

Kokotoni Wilf

1 CLEAR 24100  
2 LOAD "" CODE  
3 RANDOMIZE USR 65100  
4 LOAD "" CODE  
5 POKE 43742,0 (infinite lives)  
6 POKE 42214, X (x = number of lives)  
7 RANDOMIZE USR 41200

SABOTEUR

1 CLEAR 25200  
2 LOAD "" CODE 16384  
3 LOAD CHR\$ 22 + CHR\$ 0 + CHR\$ 0 CODE  
4 POKE 46998,0 (stops clock)  
5 POKE 29894,0 (infinite lives)  
6 LET L = USR 63972

Anyone out there got CRASH issue 34? I need the cheat info for "King's Keep". Contact Jeff Taylor

## PC8300 ROM UPGRADE

Rom replacement for the PC8300.

Available from:

Silicon Mountain Computers  
 C-12, Mtn. Stn. Group Box  
 Nelson, BC V1L 5P1

Price: \$14.95

The PC8300 ROM upgrade is an 8k eeprom mounted on a socket for insertion into the PC8300 ROM socket. Instructions are included to make the substitution. Additional instructions are given to allow switching between the original ROM and the upgrade ROM as well as making the necessary connections to the edge connector to address 64k RAM Packs. To complete the package, extensive documentation is provided to describe the modifications to the PC8300 ROM with software routines and explanations.

Fred Nachbaur of Silicon Mountain Computers has done an excellent job of rewriting the PC8300 ROM code to provide almost 100% compatibility with the ZX81/TS1000 computer (while rewriting the rom code, Fred found that it was impossible to display hi-res or quasi hi-res video: the PC8300 ULA does not allow it). In doing so, he has managed to incorporate most of the features of the PC8300 as well as adding new key commands not available on either system (IN, reading data from the address bus. OUT, sending data to the address bus. Both are available on the 2068). Fred has provided the user with the option of having a solid or flashing cursor and key beep/nobeep. A 'warm boot' reset is available in the event that you get caught in an endless loop or have a machine code crash.

Options also include LOAD monitoring, and the ability to change the video display speed, an advantage if you have games or routines that are too fast to follow.

**THE BOTTOM LINE:** If you are a ZX81/TS1000 user and have bought or are considering buying a PC8300, then the ROM upgrade is well worth the price.

Rene Bruneau

### Addendum: A SIMPLE EEPROMER by John G. Thomas

In Paul Hunter's article on Bankswitching for the TS1000 (TS Horizons part 4), he included a printed circuit and diagram for converting the Hunter Board to program the 52B13 EEPROM and are shown below

Rene Bruneau

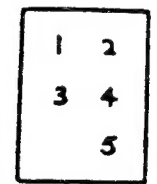
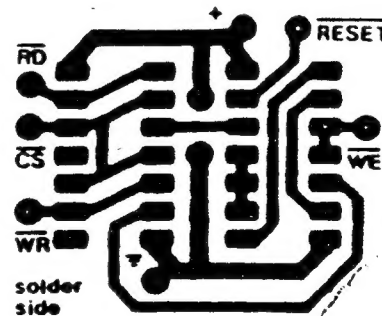
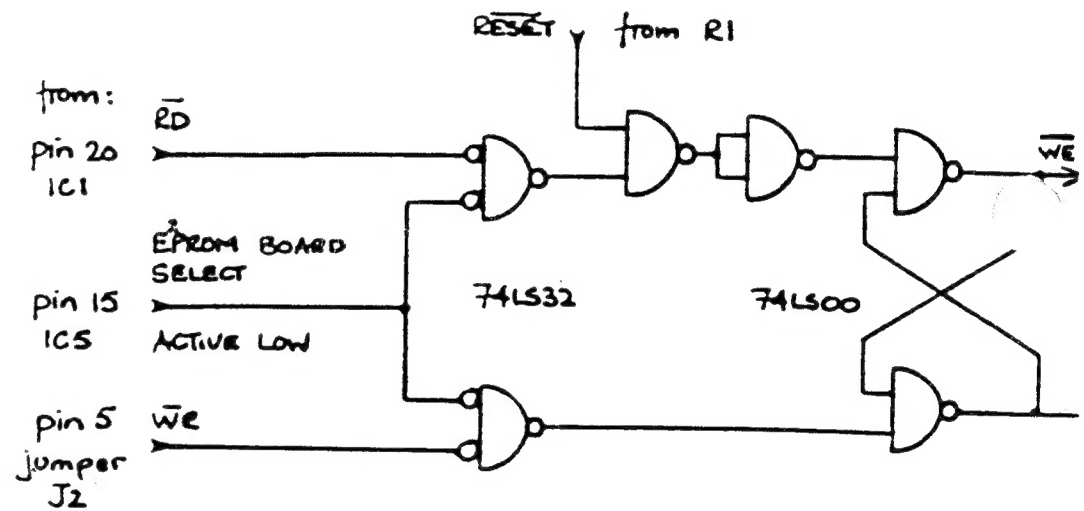

Jumper J2

Got a Question?  
 Ask the Editors!

Got an answer?  
 Tell the Editors!

Our last newsletter carried an article by Greg Lloyd, describing a RAMdisk unit that he had recently ordered from Larken Electronics. I have recently purchased one of these units, and should like to tell something of my programming experiences with it.

Firstly, when I got it I could not figure out how to use it effectively. After all, while it can contain a total of 256K memory, mine only came equipped with 64K and there really is a limit as to how many programs one can hold with that. Which programs should I place on it, etc?

On top of that I already had a second drive on my system that seemed to be only used when I wanted to copy a program. Of what use was another bit of expensive memory. And it is expensive, if compared to the memory capacity of a disk. A disk will hold 360K and costs about 65 cents. A 32K SRAM chip costs about \$15. And the RAMdisk is really a solid-state drive, not a memory expansion to your computer. That is to say, you still have only 38K of memory in your computer to play with. The RAMdisk memory is not bankswitched in to the computer; it is loaded into the computer memory the same as from a conventional drive.

However, despite this unpromising prospect I have found a very fascinating application. What I have done is to place 58 of my most useful utility files on a second disk (I call it my OMNIBUS disk), and installed it on my second drive.

I then placed the several menus (the menu program listing in the Nov/Dec '87 issue of this newsletter) required to access these files into the RAMdisk. In the beginning I had one AUTOSTART (menu) program, and several other menu programs i.e. menu.B1, menu.B2, etc., that I called up from that AUTOSTART menu. I found that presently I had used 7 of the 12 available tracks on my RAMdisk; horribly extravagant. (The RAMdisk uses the same tracks format of the other drives)

It was then suggested to me that I combine several menus into one program. This made sense, because as it was I was storing a program of about 1500 bytes onto a 5090-byte track. The other bytes, 3410 of them, were lost. I started combining menus onto a single program, and now I have 5 menu screens combined. More will follow. I use a menu option to move to the various menus.

Most of the programs themselves are on the OMNIBUS disk, installed more or less permanently in the second drive, and are called up from the menus obtained from the RAMdisk. Where a program is called up that resides on other than the OMNIBUS disk, the menu displays a request onscreen for that disk to be placed into the first drive, PAUSE's until you indicate 'ready' by a keypress, then loads from that drive.

Larry Kenny has revised his DOS EPROM, giving a new command which has proved very useful in this application. The format of this command is PRINT USR 100: NEW (or PRINT #4: NEW). This provides a 'warm' AUTOSTART capability to the DOS.

I use it this way. I have modified many of my programs to provide an exit from the program. The exit normally would take you to a STOP command. To use this new DOS command I terminate a program to the following line sequence.

```
LINE 9000 PRINT #4: GOTO 4: PRINT #4: NEW
```

The 'GOTO 4' points the DOS toward the RAMdisk and the 'NEW' initiates an AUTOSTART routine in the RAMdisk to bring up the 'menu' program. The effect is to bring up the OMNIBUS disk menu at any time from within a program with a single keystroke. Note that this new command is for all drives; its use is not confined to the RAMdisk.

This new DOS command also offers another interesting programming possibility. Invoking the 'PRINT #4: NEW' command will bring up an AUTOSTART program in the drive to which it is pointed. It does this without shutting down the computer. Thus, any M/C program presently in the computer (so long as it is not overwritten by the AUTOSTART program) remains in place awaiting use.

Larry advises that this command is in Version 2 of his DOS EPROM. Before you all rush out and ask him for it, I suggest that you wait until he has had a chance to incorporate some other features into the DOS, that he speaks of doing. Improvements to the printer driver, and changes to the NMI routine, I have heard; among others.

Now, I could hardly recommend that everyone go out and buy one of these RAMdisks. But what I have found is that for those persons with two drives it certainly maximises the use of the second drive. And it most assuredly reduces the number of keystrokes required to operate the Larken system, plus reducing the number of drive startups by possibly a half. And of course it is silent and speedy, when compared to a regular drive!

\*\*\*\*\*

Newsletters need news!

Write and tell us what you know!

Anything (almost!)

will be printed

COLOUR PRINTOUTS by Jeff Taylor

In the past few issues I have written about the VIC-1520 printer/plotter and John McMichael's TS2068 interface and software packages. Continuing this issue, I will show off two of John's latest program packages.

The first is called "Remindater" and is a combination calendar and event reminder. Most users have seen plenty of calendar programs but this one is significantly different. Not only does it produce any calendar you might want but it highlights special or important dates and provides a listing below each month all in colour. Now you have no excuse for forgetting that anniversary or birthday.

The second package is called "Demo-Pak 1" and is designed to show off the capabilities of the 1520. Each of 16 different sections displays the graphic possibilities you can use the plotter for. As an extra, Mr. McMichael has allowed the user to break into each section to examine the program's basic listing rather than his usual machine code versions. This enables the user to modify or experiment with the plotter's functions and remember, it's all in colour.

For more info contact: Mr. John McMichael, 1710 Palmer Drive,  
Laramie, Wyoming, U.S.A., 82070

MAY

\*1988\*

CHANGING FORM  
STEP 100

SU	MO	TU	WE	TH	FR	SA
1	2	3	4	5	6	7
8	9	10	11	12	13	14
15	16	17	18	19	20	21
22	23	24	25	26	27	28
29	30	31				

22 Adam's Day  
30 Hockey 820

\* REMINDATER 01988 \*  
\* John McMichael \*

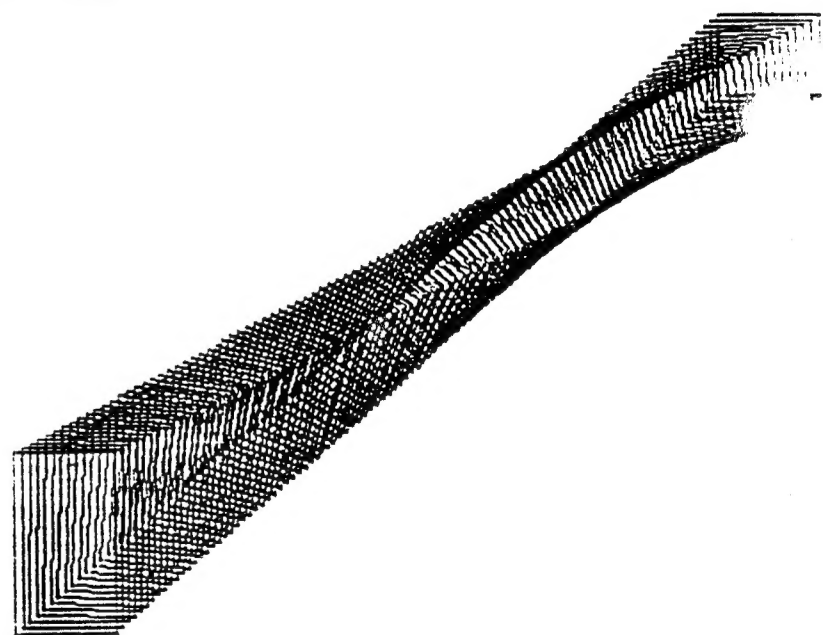

LEVEL 5 FRACTAL PLOT

HATCHING

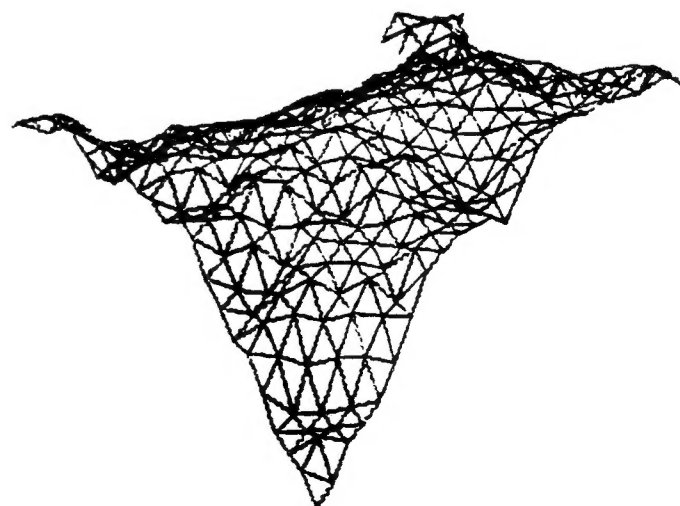
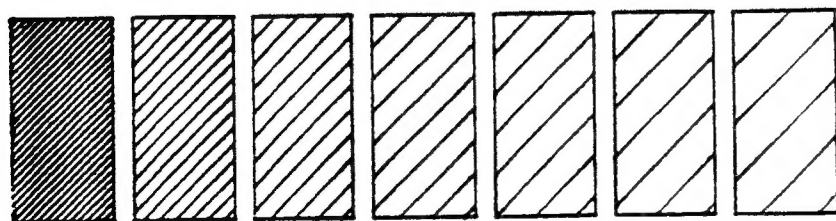

\* \* \* \* \*  
 \* THE GREATER CLEVELAND \*  
 \* SINCLAIR USER'S GROUP \*  
 \* \* \* \* \*  
 \* \* \* \* \*  
 \* March 19, 1988 \*  
 \* announcing..... \*  
 \* The Timex-Sinclair-Amstrad \*  
 \* Computer Users \*  
 \* 1988 MIDWEST Regional Conference \*  
 \* August 26 & 27, 1988 \*  
 \* Cleveland, Ohio \*  
 \* \* \* \* \*

The Greater Cleveland Sinclair Users Group will host the third annual MIDWEST Timex-Sinclair- Amstrad gathering on Saturday and Sunday, August 26 & 27, 1988.

Our theme for this event is; "Users - learning from other Users" - of ZXs, 2068s, Spectrums, QLS, and Amstrad PCs and PCWs.

Displays, demonstrations, and presentations by individuals, user groups, software authors, hardware developers, and vendors will be emphasized.

The assembly will be held at the "Beck Center for the Arts", a Cultural Arts complex in Lakewood, Ohio, a western suburb of Cleveland. This is not a hotel site; attendees will need their own in-town transportation.

We are now seeking volunteers for seminar-type presentations, and are asking users groups and vendors to participate in co-sponsoring the event. A Co-Sponsor is any one who books and pays for a \$25.00 exhibit table(s) now. Co-sponsors funds will be used to support Conference publicity.

Please direct inquiries to: Andy Kosiorek, President, Clevel. Sinclair UG on Compuserve at ID # 75046,3420, on Cleveland Freenet BBS, (216- 368-3888), at ID #aa236, or c/o the SYSOP, on Timelines T/S BBS, (216-671-6922 10PM to 6AM-EST). Or you can write to the Greater Cleveland Sinclair Users Group c/o 2192 Glenbury Ave. Lakewood, Ohio, 44107.

Reserve the dates on your calendar now!

Additional details will be posted as plans are developed.

A SPECIAL PRESS RELEASE

FROM: CCAT/S USER GROUP  
OREGON CITY, OR 97045  
AND

FOR RELEASE: July 1, 1988

LOCAL COMPUTER BUFFS TO ATTEND COMPUTER FAIR TO BE HELD AT THE COSMOPOLITAN HOTEL IN PORTLAND, OREGON AUGUST 6TH AND 7TH 1988.

Joint sponsors, RMG Enterprises of Oregon City, and Time Designs Magazine of Colton, Oregon, announced the Third Annual International/Great Northwest TS Mini-Fair to be held the weekend of August 6th and 7th 1988 at the Cosmopolitan Hotel in Portland, Oregon.

The event will include door prizes, vendor and user group booths, seminars on specialty programming, hardware tips and uses of all Timex and Sinclair computers, a round-table discussion, tours of the local scenic area and the famous Portland Zoo.

A number of nationally known vendors will be exhibiting at the fair, including such notables as RMG ENTERPRISE, TIME DESIGNS MAGAZINE, AMERICAN MICRO CONNECTION AND GREY & CLIFFORD COMPUTER PRODUCTS among others.

The seminars will cover such topics as Machine Code programming the Z80 microprocessor chip, Architecture of the 68000 CPU, using Archive database to its FULL capacity, Telecommunications, GIF graphics, an overview of the QL-What it is-What it could be, CP/M on TS computers, and others. Seminar speakers include Mike de Sosa, author of TAKING THE QUANTUM LEAP and QL advocate, Syd Wyncoop, author of the Z80 series of articles in TIME DESIGNS MAGAZINE as well as S & K Software titles including THE KRUNCHER, TRACER and EXPRESS. Michael Carver, current president of CCAT/S, a Timex/Sinclair User Group, Vincent Lyon, author of ARCHIVE MASTER, and several programs for the Timex 2068 and Sinclair QL. And let's not forget Ed Grey of Grey & Clifford, one of our telecommunications supporters, or Jack Dohany, of 2068 FairWare fame.

Scheduled tours for attendees and their families include a Saturday tour of the Columbia River Gorge and a Sunday tour of Portland's famous Washington Park including the Portland Zoo, the World Forestry Center, Oregon Museum Of Science And Industry, the Washington Park Rose and Japanese Gardens. These tours will be provided at a VERY nominal cost.

Local attendees will include...(enter your info here).....

Additional information is available from RMG Enterprises, Time Designs Magazine or the Cosmopolitan Hotel.

# Add an ON/OFF Switch to Your QL

a modest hardware project

by John Riley

I'll never understand what it is that Sir Clive has against the simple and convenient on/off switch. Neither the ZX81, the Spectrum, nor the QL were provided with them. Having to always be plugging and unplugging the power supply is not only bothersome, it quickly wears out the plug components! This started happening to my QL recently, and the wear on the power supply connector expressed itself in unpredictable crashes of the computer. I called Tom Bent, who prescribed cleaning the contacts with a spray from Radio Shack and mashing the Phillips connector with a pair of pliers to get rid of the looseness that had developed. It helped some, but the problem persisted. I don't know how it is with you, but losing a half an hour's work in an instant is a very frustrating experience for me!

I resolved to attack the source of my problem, the connector, and replace it with a switch. Trotting over to Radio Shack again, I bought a triple-pole, double-throw switch (part #T27500 661) and a little 2 1/8 x 3 1/4 inch "experimenter's box" (part # T27000230)--total investment, \$5.23. With great satisfaction I cut the Phillips connector off of my power supply lead. The power supply was unplugged from the mains, of course! Some trimming of insulation revealed three color-coded wires, red, green, and blue. A little fooling around with a volt/ohm meter determined which wire went with which pin on the Phillips connector (see Fig 1 below). Next I drilled three holes in the experimenter's box, one on top for the switch, and one on each end for the wire to pass through. Wiring the switch

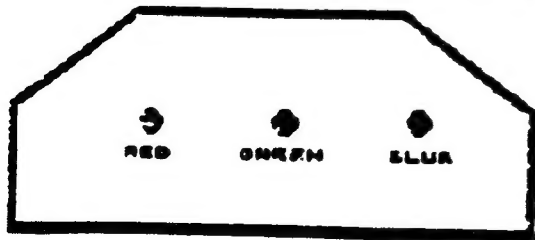

Fig. 1 - The Receptacle  
on the back of the QL

was a straightforward proposition, even for me!

The next big decision that I had to make was how to wire the newly-switched power supply into the QL itself. Taking the cover off the computer, I quickly realized that it would require a major disassembly to get to the portion of the motherboard that the male Phillips receptacle was soldered into. Therefore, I decided to take the easy way out—I soldered my wires directly onto the pins of the Phillips receptacle! It was tight work, but do-able using a small-tipped soldering iron. Looking from the BACK of the QL, the wiring sequence is: blue wire to the right pin, green wire to the center pin, and red wire to the left pin. I put some small plastic tubing on the wires before I soldered them onto the pins, which when pushed up onto the finished connections provided protection and insulation for them.

Switching on the QL (what a novel experience!), I was rewarded with the familiar power-up display. And guess what--no more crashes! Of course, my power supply is now permanently wired to the keyboard, but that is OK for me since I never move it. The solder connections to the Phillips pins may prove unreliable in the long run, and if they do I will go through the bother of removing the voltage regulator and microdrive assemblies so that I can wire straight into the motherboard. Complete instructions for this disassembly can be found in Volume 1, Issue 1 of Quantum Levels.

Here are some trouble shooting tips if you decide to do this to your QL. Do a continuity check on your own beheaded Phillips plug to make sure that the color coding of your power supply wires is the same as mine. Be careful to avoid solder bridges when soldering the wires to the pins. Tinning the pins first makes the soldering easier. Check the Phillips receptacle for wobbling--if it does, "shim" it with some thin plastic between the top of the receptacle and the QL case to eliminate another potential cause for crashes. If when you power up

continued on page 14

6-4

your computer you get a deep-toned buzz from the speaker instead of the first screen, turn off the computer immediately, because you have managed to reverse the red and blue wires. If you turn it on and nothing happens, then either the red or green wire or both is not making the proper connection. If you turn it on and the computer works but your printer doesn't, then the blue wire is not making a good connection. And don't forget, your switched power supply is only switched IN FRONT OF the transformer, so don't walk away from your machine and leave the transformer cooking 24 hours a day. Get a surge protected, switched power strip to plug your entire system into, and you won't have to worry about that problem.

That's it! I like having an on/off switch on my QL! I hope that you will, too.

NINE KINDS OF PROGRAMMERS:  
We're not just nerds anymore!



consultant

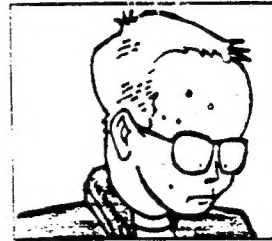

developer



hacker



hobbyist



lifer



pirate



profiteer



researcher



unemployed

Postmaster, if Undelivered Return to :

Toronto Timex - Sinclair Users Club  
P. O. Box 7274 Sin. A  
Toronto, Ont., M5W 1X9  
Canada

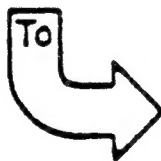

TORONTO TIMEX-SINCLAIR USERS CLUB

14 Richome Court  
Scarborough, Ont.  
M1K 2Y1

Les Cottrell,  
108 River Heights Drive,  
Cocoa, FL 32922 USA

Dear Les,

Thank you for your cheques for \$12 for a subscription to our newsletter (Jeff Taylor turned your letter over to me). I am enclosing a membership card, also a sheet which tells a bit

*Sincerely George Chambers. (Secty T.T.S.U.C)*  
*my printer is acting up ie TASWORD is sticking in an end of page spacer!!*

more about our club. I am also enclosing a copy of our most current newsletter.

You say that you are interested in past issues of the newsletter which contain articles about the LARKEN disk system. This is a bit of a broad statement. What I mean is this. We have been publishing articles about the Larken ever since it appeared. However the Larken system has been through quite an evolution, and a lot of the original material deals with the early vintage which is no longer applicable. If you tell me just which Larken system you have I can get a better idea of what you might be interested in. The LKDOS with 5090 bytes per track, or LDOS with 1960 bytes per track, for example. What type of Drives do you have, double-sided or single, etc.

I have the current Larken system with version 3 DOS. This DOS has just come out, and has a much better printer control, also something called sequential filing capabilities.

On my system I have two DSDD drives, and one Quad Density drive. Then I have a Larken RAMdisk with 64K. I also have an RGB monitor, a Smith-Corona daisywheel printer, modem, and an auxiliary keyboard. I have been very active in writing utilities for the Larken system.

The item in TDM did not really tell the whole picture about our dues structure. Our club dues are actually \$20 a year. Because many people seemed to be interested in receiving the newsletter only, we put in place a \$12 figure for that. Now if you are an active Timex type, I think you would find it worthwhile to take out a full membership. Not that I am trying to pressure you, but we have a very strong Larken contingent in our club, which you could find useful. As well as a good tape program library for the TS2068.

Do drop me a line,

Sincerely,

TORONTO TIMEX-SINCLAIR USERS CLUB

December 3, 1988

14 Richome Court  
Scarborough, Ont.  
M1K 2Y1

Les Cottrell  
108 River Heights Drive  
Cocoa, FL 32922

sample of  
adventure disk  
suite

Dear Les,

Received your disk yesterday. Thank you very much.

I am enclosing a disk that has several programs on it. One of them is the CRACK program that you mentioned was missing from the other disk.

The disk that I enclose has some programs which can be used on the 2068, and others which will only work in the Spectrum mode.

The AUTOSTART is for the 2068 mode, and it shows the programs which are for the 2068. There is another program called "menu.B1" which should be loaded in the Spectrum mode. It shows the programs which are to be loaded in the Spectrum mode.

With the AUTOSTART menu you can access the HELP file. It is a Tasword file which you can print out if you care to. It describes the features of each of the programs on the disk.

In addition to these programs I have also added several NMI-saved programs to the disk. These are adventure games which you say you are interested in. I hope you find them interesting.

One of them, HACKER, is reviewed in our current newsletter. What I suggest is that you lift the adventure games off the disk because they are not really part of the suite of programs that the disk is supposed to be comprised of.

2<sup>nd</sup> Letter

One of the program utilities I have just completed and which is on the disk is BOPEEP.B1. I think you will find it very interesting to use, particularly if you are interested in entering games pokes that are published in magazines.

You mention an idea for a quick return to menu using the instruction "GOTO menu". With the new DOS, and I forget whether it was with the version 2 DOS, you can get an AUTOSTART up and running by entering PRINT USR 100: NEW. I tend to put that into many of my programs. That is to say, I offer the option of re-running the program, or going to the RAMdisk menu with a program line PRINT #4: GOTO 4: PRINT #4: NEW

I have a great many Spectrum games on disk. I can send you a listing of them. They are not in any particular grouping, except maybe as I received them. I have not put them in the library tapes because the majority of them are Spectrum, and most members do not have the Spectrum ROM. Also many of the programs are difficult to copy successfully.

We do have an earlier version of the INDEX program that was made for the version 2 EPROM. I can send you a copy if you wish.

Sincerely,  
George Chambers